

A pair of hands, one larger and one smaller, are shown holding dark, rich soil. The larger hand is on the left, and the smaller hand is on the right. The soil is being held in a way that it appears to be falling or being shared. The background is a vibrant green with a watercolor-like texture, transitioning from a darker green at the top to a lighter, more yellowish-green at the bottom. The overall mood is natural and nurturing.

PHYLAZONIT MYRAZONIT

Product Catalogue

2020

*„We see soil much more than a physical medium:
a living, organic unit
which forms the basis of crop production.”*



**AT THE SERVICE
OF SOIL SINCE**

— 1 9 8 3 —

The soil has become too much of a second nature to us because it is available everywhere and anytime and we abused it as we made it our food source for such a long time.

*We have forgotten: soil is one of our greatest treasures,
it should be cultivated, not just used!*

The technology we have developed is able to repair, restore the state of the soil as a growing medium and bring it back to life again. By using Phylazonit products, an environment friendly, yet economical and safe production can be achieved and as a result, higher yields and more content values from nutrition standpoint.

All of our products can also be used in organic farming.





HUNGARIAN PRODUCT FROM HUNGARIAN FACTORIES!

Thanks to the investments into capacity expansion in the past year, the Phylazonit bacterial products are made only in Szabolcs-Szatmár-Bereg county from 2020. We do not manufacture any other products at the facility. Only Phylazonit related researches, developments and production take place within the factory walls in order to achieve professional production in all aspects. Every material we use and even the manufacturing plant itself is the result of the work of Hungarian manufacturers, just as the owners of Agrova Ltd. are also Hungarians.

The Phylazonit brand has now won the **Business Superbrands** award for the second time and as a revolutionary solution for the application, our Phyller application machinery supplemented with the Temposensor Basic control unit has won the **Value and Quality Award** and it also became the winner of **Quality Innovation of The National Award**.

These awards reflect it well that the Phylazonit brand marketing has reached a higher plateau, our company is no longer limited to selling certain products but also offers an applicable technology and

spirituality to farmers which is a guarantee of competitive cultivation and can be well integrated into environmentally responsible farming. Without it, one of the important goals of our mission is in-

conceivable: producing healthier foods. This complexity is reflected in Phylazonit brand. In this regard, we work closely with research institutes, public authorities and a number of key players in agriculture in order to better integrate the expectations of the future into our technology.

From factory directly to Farmers!

We do not store our products but deliver them directly from our factory to our customers and using our fast logistics background the purchased formulations can reach them within 48 hours anywhere in the country. Our bacterial products are freshly packed, we fill our tanks of different sizes only a few hours before delivery. This way we always deliver it in the best quality, for the satisfaction of our customers. We always deliver as much of the product as our customers need at the very moment thus the quality of product does not deteriorate because of variable weather conditions or possible technical problems 48 hours anywhere in the country. Our bacterial products are freshly packed, we fill our tanks of different sizes only a few hours before delivery. This way we always de-

liver it in the best quality, for the satisfaction of our customers.

We always deliver as much of the product as our customers need at the very moment thus the quality of product does not deteriorate because of variable weather conditions or possible technical problems.

We are People-Oriented with Quality Assurance!

In our logistics and sales approach, customers always come first. Our consultants contact the farmers directly and pass over all our knowledge to them. We always recommend the easiest and most efficient implementation technology for them. We not only sell Phylazonit products to our customers but we help them through the whole process of their agricultural production line and we provide them with professional support.

We guarantee the constant high quality of our products. Since 2012, each member of the Phylazonit product family is provided with a seal of a unique identifier, guaranteeing unopened condition. We are proud to be in a relationship of trust with our customers.





LABORATORIES MEETING ALL NEEDS

Dedicated microbiologists and researchers, who have high professional experience, work in our laboratories serving production with the purpose of meeting the highest quality requirements of our special bacterial strains year after year. We provide the most effective solutions for maintaining the fertility of the soils, tailored to our partners' needs.

In the laboratory occupying the entire upper level of our plant in Beszterec, developments have taken place in several stages in recent years, new equipments, experimental equipments and machines have been acquired. **Our phytotron chambers have been developed for modelling the effects of climatic factors on crops.** By changing parameters required for plant growth and development - soil type, air temperature, humidity, length and intensity of illumination, precipitation, etc. - it is possible to set up any experiment in the chambers at any time of the year.



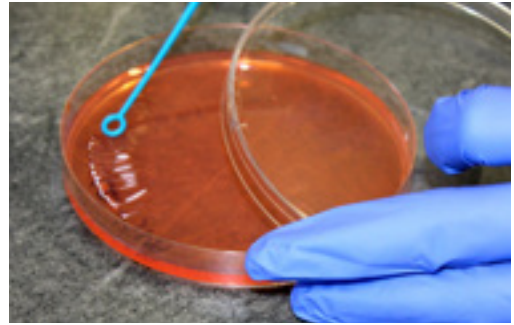
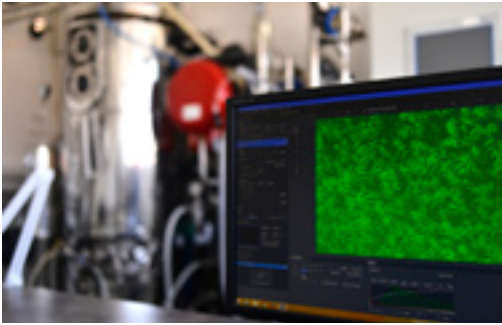

To increasing the efficiency of manufacturing and research work, the various work processes and tests (e.g. sample preparation, microbiological tests, inoculant production, analytical tests) are completely separated and take place in isolated areas on the premises.

The primary manufacturing process in our laboratories is the production of inoculants at various scales. From the few deciliter flasks to the 20,000 liter tanks, we continuously grow our bacterial strains on varying media.

Our products consist of several bacterial strains which are mixed in different proportions at the end of production according to the specifications of the product. During the production work, we also pay special attention to the documentation of the processes, the control of the number of germs by means of continuous, microscopic and colony morphological examinations and the examination of the viability and storability of the compounds. Strain isolation and the efficiency testing of our existing and under-development bacterial strains are ongoing.

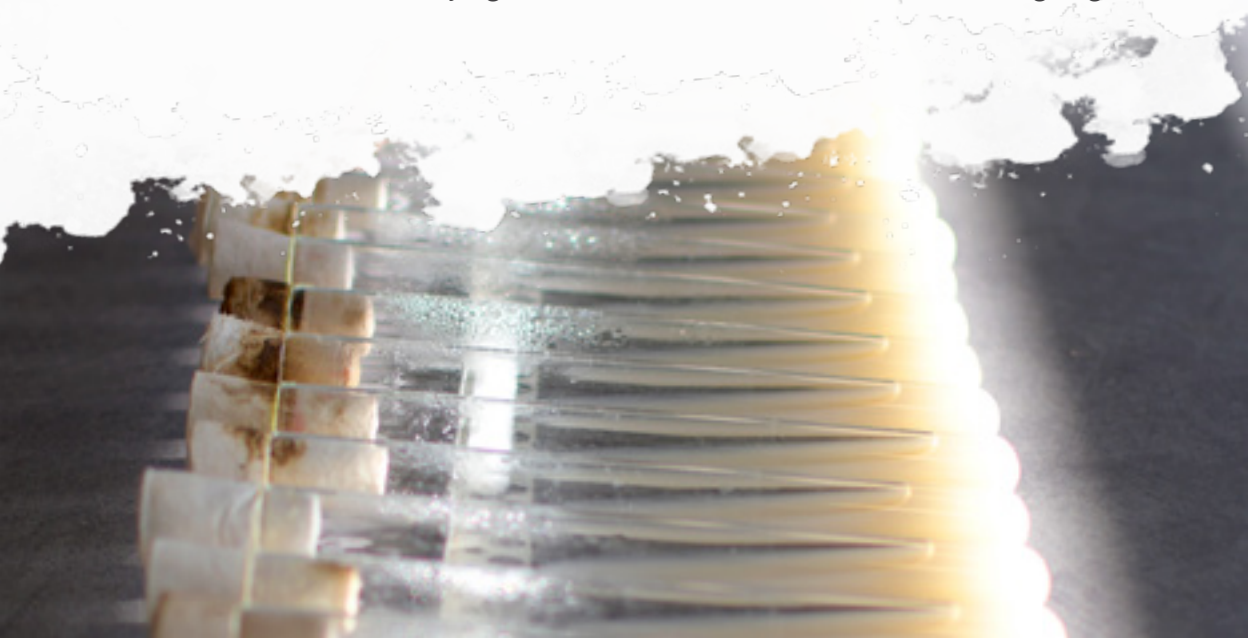



BUSINESS PARTNERSHIP OPPORTUNITIES

Our company has come a long way over the past decades – from a small family business to a modern enterprise, still owned by the founders. By now, we extended our activities to cover the whole product chain: the production, trade, research and also the development of the products.

The quality and innovation represented by our products have been awarded by several Hungarian and international prizes, while our ethical and reliable business behaviour and economic stability gained us a Bisnode AAA qualification.

After becoming a successful market player in Hungary, we are aiming to

expand our business abroad. As a part of this goal, we are currently looking for business partners, who would represent our products as a retailer on foreign markets, is adept in agriculture, while also has a producer network in a specific country. Last but not least, who shares our vision and mission: "Soil life is our life"

We are also open for selling our manufacturing know-how to investors who would like to set up their own business and factory in their countries.

In case you are interested in buying or representing our products, or should you have further questions, please contact our colleagues at **info@phylazonit.com**

Péter Vajda

owner, CEO
vajda.peter@phylazonit.hu

Szilvia Palakovics

international corporate representative
szilvia.palakovics@phylazonit.hu
+36(70) 933 1409

You can also find out more about our products on **www.phylazonit.com**

Postal address:

Agrova Kft.
Hungary-4400
Nyíregyháza, Kossuth tér 6



A hand is shown from the top right, reaching down towards a field of wheat. The scene is backlit by a bright sun, creating a strong lens flare and a hazy, golden atmosphere. The background shows a field of wheat stretching towards a horizon under a bright sky. The overall mood is one of care, growth, and natural health.

PHYLAZONIT
PRODUCT FAMILY

4. Soil protection and nutrient cultivation

Using appropriate agrotechnics.

1. Phylazonit Stubble Decomposer

We improve the condition of the soil as a growing medium.



3. Energy Foliar Fertilizers family

Stress reduction and balanced nutrition.

2. Phylazonit Soil Inoculant, Soil Regenerator, Soy

Treatment of the root zone of the plant.



PHYLAZONIT® **STUBBLE DECOMPOSER**

Soil structure repair - intensive soil life!

With the help of Phylazonit Stubble Decomposer we accelerate and control the decomposition of dead plant parts and their turning to nutrients; the vast majority of the nutrient can be obtained by the plant and all other micro-organisms living in the area within a marketing year. In this way we can stimulate the microbial life of the soil. Active soil life has a positive effect on soil structure and cultivability (formation of micro- and macro-aggregates).

Easily, rapidly degrading plant parts are returned to the nutrient cycle during the growing season, while slowly degrading organic matter promotes humus formation. The phosphomobilizing strains in the composition help the uptake of phosphorus of organic and inorganic compounds.

Usage:

For the treatment of dead stem residues of any crop.

Environment:

Dead plant parts for nourishment.

We treat the area and not the culture with the product. In order to increase the improving effect of the preparation on soil life and soil structure, it is advisable to treat the area for several consecutive years.

Composition:

Bacillus circulans, *Azotobacter chroococcum*, *Pseudomonas putida*, *Bacillus megaterium* bacterial strains optimized for stubble decomposition. Germ count: 4×10^8 pcs / cm³, nutrient medium

Application:

Arable crops: 10-20 l / ha.

Horticultural crops: 10-20 l / ha.



Method of application:

The compound can be used in all arable and horticultural plant cultures in an amount of 10-20 l/ha (150-200 l/ha quantity of liquid) applied directly on the stubble or the stem residues by means of a special device mounted on a tractor or a sprayer and immediately worked into the soil.

The treatment is recommended to be carried out in an operation in which the majority of the stubble remains in the soil and good quality tillage can be carried out in the area at a depth of 10-25 cm. As the strains in the compound tolerate dry soil to a sufficient degree, the application does not need to be timed to the weather but to the condition of the soil!

Why is the use of Phylazonit Stubble Decomposer beneficial?



▷ nutrients in stubble residues become available for the plant



▷ promotes humus formation thus increases soil organic matter



▷ decreases the number of pathogens and pests overwintering by decomposing stubble residues



▷ soil structure will significantly improve thereby improving its water, air and heat management



▷ due to the improvement of the soil structure, the tractive effort requirement may decrease during tillage thus reducing fuel consumption (even up to 20-30%)



▷ pH level of the soil will shift toward neutral.





PHYLAZONIT® SOIL INOCULANT

Effective nutrient release - better utilization

The bacteria found in the Phylazonit Soil Inoculant will propagate on the root surface and exert their multiple positive effects on it. First, they stimulate root formation thus providing larger surface for nutrients and water uptake. Second, by living on the root surface they help the host plants in taking up the nutrients thereby “relieving” the plant of energy-intensive processes and that energy can be used by the host plants for stimulating other vital processes. Third, by binding the nitrogen content of the soil gases and mobilizing the phosphoric forms bound in the soil they will provide surplus nutrient to your crops.

Usage: Treating the root zone of any culture.

In case of wide-range hoeing crops, it is injected directly into the seedlings by a

seeder-mounted applicator; in case of grain row spacing, we introduce it into the soil down to sowing depth along with the seedbed preparation work.

Mechanism of action: Nitrogen-binding bacteria bind elemental nitrogen from the soil air and convert it into forms of nitrogen that can be taken up by plants.

Phosphomobilizing bacteria supply our germinating plant with nutrients. Through secondary metabolic processes, bacteria produce organic acids that stimulate plant-soil metabolic processes.

Environment: A layer of mucus secreted by plant cells, root cells, and microorganisms.

Application:

Arable crops: 10-20 l/ha.

Horticultural crops: 10-20 l/ha.



Method of application:

It can be used in all arable and horticultural plant cultures in amount of 10-20 l/ha, with 100-300 l/ha water quantity, applied on the whole land surface prior to sowing, planting and immediately worked into the soil, or by means of special device with quantity of 20-40 l/ha liquid applied on the whole surface then mixed into the seed bed or injected into the seed furrow in one pass with seeding.

Composition:

Bacterium strains (Pseudomonas putida, Azotobacter chroococcum, Bacillus circulans, Bacillus megaterium) in ratio optimized for soil inoculation. Germ number: 10^9 per cm^3 , nutrient medium.

Why is the use of Phylazonit Soil Inoculant beneficial?



▷ bacterial fertilizers develop a thicker and deeper root system that helps intense nutrient uptake and to endure drought conditions



▷ a thicker, more powerful stalks are developed with better nutrient and water storage



▷ improves the stress tolerance of the host plant through its balanced nutrition and water supply



▷ the bacteria applied promote plant growth and ensure their development through their optimal hormones and vitamins production



▷ allows the plant to absorb phosphorus from the soil



▷ improves the efficiency of fertilizers and provides rich nitrogen source





PHYLAZONIT[®] SOIL REGENERATOR

Promotion of rooting, protection against pathogenic soil fungi

The bacterial strains found in Phylazonit Soil Regenerator have been selected as to stimulate rooting and accelerate germination by their hormone production. Through their metabolism processes they produce antibiotic-like substances which are avoided by soil fungi.

Due to their Siderophore production they limit the growth of harmful fungi in the vicinity of the root surface by binding and utilizing the iron essential for their vital activity.

Pseudomonas and Bacillus strains which adapt well to different soil types and conditions and multiply rapidly, displace harmful microorganisms by occupying their habitats. This attribution may be particularly im-

portant on farms where they are unable to meet crop rotation requirements. It is similarly recommended in cases where successive crops may be damaged by the same diseases.

Phylazonit Soil Regenerator, like all our products, can be used in bio-farms so it can be one of the most important product to organic farming.

Usage: Treating the root zone of any culture.

Mechanism of action: The bacteria found in the product nourish the germinating plant and protect it against pathogens. Through secondary metabolic processes, bacteria produce substances that repel soil-dwelling fungi; As a result of the production of siderophores, the growth of fungi in the vicinity of the root surface is limited (through the binding of iron), thus reducing their harmful effects



and obtaining a healthier, more even and nourished plant population.

Environment: A layer of mucus secreted by plant cells, root cells, and microorganisms.

Composition:

Pseudomonas putida, *Pseudomonas fluorescens*, *Bacillus megaterium*, *Bacillus subtilis* bacterial strains.

Germ count: 10^9 pcs / cm^3), nutrient medium

Application:

Arable crops: 10-20 l / ha.

Horticultural crops: 10-20 l / ha.

Method of application:

VIt can be used in all arable and horticultural plant cultures in amount of 10-20 l/ha, with 100-300 l/ha water quantity, applied on the whole surface prior to seeding, planting and immediately worked into the soil, or by means of a special device with 20-40 l/ha quantity of liquid applied on the whole surface then mixed into the seed bed, or injected into the seed furrow in one pass with seeding.

Why is the use of Phylazonit Soil Regenerator beneficial?



▷ promotes uniform growth of the crop



▷ decreases the negative effect of monoculture



▷ stimulates uptake of nutrients



▷ produces stronger, more developed crop



▷ improves resistance and stress tolerance





PHYLAZONIT[®] SOY

Increased nodulation - higher yield

Inoculation of the soil with special rhizobium bacteria is essential for the economical cultivation of soybeans in Hungary as it is not a native plant. The strains in Phylazonit Soy were formulated, in addition to the formation of tubers with high nitrogen-binding capacity, to promote the dynamic initial development of the plant and to form healthy, well-resilient, high shrub layer plants.

Usage: Treating the root zone of soybeans.

In the case of wide-row sowing, it is directly injected into the seed furrow with a seeder-mounted applicator, and in the case of grain-row sowing, it is worked into the soil to the depth of sowing together with the seedbed preparation operation.

Mechanism of action:

The bacterial strain *Bradyrhizobium japonicum* in the medium helps to supply the soybean with nitrogen by forming nitrogen-binding tubers and with binding atmospheric nitrogen. The bacterial strains *Pseudomonas* and *Bacillus* feed and protect the germinating plant against pathogens. Through their secondary metabolic processes, the latter bacteria produce organic acids that stimulate the soil metabolism processes of the plant.

They limit the growth of pathogenic soil fungi in the vicinity of the root surface thus reducing their harmful effects resulting in healthier, more evenly developed and nourished crops.

Application:

For inoculation of soy: 10-20 l / ha.



Method of application:

From 10 to 20 l/ha for soybean inoculation with 100-300 l/ha water, applied onto the entire surface immediately before sowing or seeding, or by means of special device in 20-40 l/ha liquid volume applied on the whole surface then mixed into the seed bed or injected into the seed furrow in one pass with seeding.

Composition:

Bradyrhizobium japonicum, *Bacillus megaterium*, *Bacillus subtilis*, *Pseudomonas putida*, *Pseudomonas fluorescens* bacterial strains. Germ count: 8×10^9 per cm^3 , nutrient medium.

Why is the use of Phylazonit Soy beneficial?



▷ promotes uniform growth of the crops



▷ promotes the formation of nitrogen-fixing nodules



▷ reduces the amount of fertilizer to be applied



▷ stimulates nutrient uptake



▷ increases the resilience of the crops.





**ENERGIA
FOLIAR FERTILIZER FAMILY**

Trace elements such as enzymes are essential components of the life processes of plants. Slight deficiencies of micronutrients rarely cause visible symptoms, however, they may result in 10-30% yield loss. When a micronutrient deficiency has obvious symptoms we can expect significant loss in yield.

Some metals present in plants in small amounts typically move slowly, meaning during the intensive growth periods young shoots may show deficiency symptoms. We need to adjust the application of foliar fertilizer to these periods.

It is not our intent to feed the plant with macronutrients with foliar fertilization as the nutrient uptake through leaf surface is pretty low.

It is well suited for balanced nutrient supply for plants, and the wide ranges of secondary nutrients and trace elements of the foliar fertilizer also improve the utilization of nutrients taken through the root system. The nutrient requirements of rapidly developing crops often exceed the nutrient uptake capacity of the root system.

Often the unfavorable soil conditions (compaction, dusting, desiccated soil) or extreme weather conditions (drought, too cold or warm weather, leaching and sublimation losses) inhibit nutrient uptake. The relative predominance of some nutrients can inhibit or reverse the uptake of other nutrients. And that is why we have developed a leaf-feeding technology that incorporates the benefits of two formulations.



„An important tool for the efficiency of our products is the proper application and agrotechnics which are integral part of Phylazonit technology.”



EnergiaHumin

It immunizes and vitalizes.

During the initial development of the plants, a formulation containing macro- and microelements, humic and fulvic acid is used to treat early stress effects and possible nutrient deficiencies. The fulvic acid in the formulation also has a significant effect on life processes: it enhances the metabolic processes of the cells (eg improved oxygen uptake) and chelates certain nutrients thus helping them to enter the plant cells, strengthening the immune system.

Application:

It is recommended for leaf treatment of all arable crops for improving their conditions, applied in a dosage of 4-10 l/ha with 200-350 l/ha water volume. It is recommended to apply it in a concentration of up to 3% during

the period from 3 to 6 leaves of the plant to flowering. It is not recommended during flowering. When mixed with other compounds a mixing test should be performed.

Mechanism of action:

In plant protection treatments, several active ingredients are typically used together. These herbicides, fungicides and insecticides, no matter how gentle they are to the plants, cause stress, often in the form of phytotoxic symptoms (yellowing, scorching). In this case, the development of the culture slows down for days, even a week, or may stop. This common situation is helped by the high humic acid content of Energia Humin which can be an important source of nutrients for the plant. The product contains a total of 11 active ingredients (N, P, K, Fe, Cu, Zn, B, Mn, Mo, Ti, Humic acid / fulvic acid)

and is excellent for supplementing micronutrients.

It is easily absorbed through the leaves and thanks to the humic acid, the active ingredients remaining on the surface do not cause scorch.

Method of application:

In combination with plant protection treatments or alone. The use of tackifiers is recommended (except for copper-containing agents). Recommended dose 4-10 l / ha. Its use in flowering is not recommended.

Recommended application:

- **corn:** up to 4-8 leaf stage
- **sunflower:** 4 to 8 leaf stage
- **cereals:** from 3-leaf stage (autumn) to stalk (spring)
- **rapeseed:** from 4 leaf stage (autumn) to stalk (spring)
- **soy:** up to 4 node-stage

Why is the use of Energia Humin beneficial?



▷ it is a direct source of nutrients with more than 70 minerals and trace elements



▷ increases chlorophyll content and photosynthetic activity



▷ improves the quality of the crop



▷ improves nutrient uptake and reduce the risk of scorching due to humic acid



▷ it speeds up the nutrient response of plants and improves nutrient utilization



▷ increases metabolism



▷ increases the pH and temperature tolerance of the plant



▷ strengthens the immune system, improves resistance





Condition improvement through foliage

As a closing element of Phylazonit Technology, the plants in intensive growth is treated with a formulation with high content of N, Mg, S, which also contains 6 microelements (B, Cu, Fe, Mn, Mo, Zn) essential for the plants. Energia Plus foliar fertilizer contains N in the form of amide which is excellent for absorption through leaves: due to its small molecular size, it can easily pass through the plant cuticle; it has no scorching effect and also promotes the absorption of other compounds.

Application:

For foliar treatment of all arable crops, to improve their condition in the amount of 20-30 l/ha with the

amount of 200-350 l / ha of water, in the period from the 8-10 leaf-stage to flowering.

Mechanism of action:

During the period of intensive growth, the nitrogen demand of the plant increases exponentially so we chose a form of nitrogen that is absorbed through the leaves with high efficiency and does not cause scorching. At the recommended dose of 30 l / ha, 5.4 kg of active ingredient per hectare is applied.

Since plants need more than one element for development we have supplemented the formulation with all the meso- and microelements essential for plants. Due to its special composition, the foliar fertilizer is not plant-specific and can be used successfully on any culture.

„I was amazed to see how the treatment with Energia Fertilizer family beneficially tidied up my autumn wheat sowing. It mitigated the harmful effects of plant stress and saved the crops! ” – Roland Révész, family farmer, Dombrád

Method of application:

In combination with plant protection treatments or alone. The use of tackifiers is recommended. In case of co-application with other compounds, it is advisable to perform a mixing test.

Recommended application:

- **maize:** from 8-leaf stage to tasselling
- **sunflower:** from 8-leaf to the stage of growing Bud
- **cereals:** from stalk to flowering
- **rapeseed:** from the beginning of stalk to flowering
- **soybeans:** from a 4-node stage to flowering, then during grain filling period

Why is the use of Energia Plus beneficial?



▷ due to its favorable nitrogen form, the utilization is perfect



▷ can be well integrated into nutrient replenishment technologies



▷ foliar manure does not cause scorching



▷ promotes the uptake of other nutrients and compounds



▷ helps prevent microelement deficiency



Arable experiments

Our products, new and already in the market, are continuously examined through tests conducted in our laboratories, our phytotron experiments and using results from the culture vessels, as well as field experimental data. The success of the GINOP project conducted in cooperation with several universities and research institutes resulted in new tools to expand our product range to protecting fragile soil as well as to the restoration of already damaged soil. In the development of the recent period the only priority was to increase the efficiency of the application apparatuses. To achieve perfect application, we have developed an application unit that can be used for optimal application of bacterial strains to the soil using precision methods.

As our variety experiments and agrotechnological experiments, we carry out new tests every year in several areas of the country – besides the old test sites – and by using all these results, our products give effective help to farmers for better sustainability in organic farming.

In our arable experiments, we work together with national universities, research institutes, successful farms and our partners. We make our results available at our national professional events, other professional forums, printed and online publications, and social media so that our technological developments can become an everyday practice.

The joint cooperation of our well-equipped laboratory, qualified staff, network of consultants and our professional partners enables us to provide appropriate answers to the challenges and questions arising in the agricultural and crop production sectors of the present age, and to offer usable technologies.



Autumn wheat - 2019'

📍 Hajdú-Bihar county

Experiment : operational experiment using Phylazonit Stubble Decomposer (15 l / ha)

Cost: cc. 44 USD/ha ; cc. 37 EUR/ha

▶ **Results compared to control field:** + 900 kg/ha

📍 Böhönye

Experiment: operational experiment using Phylazonit Stubble Decomposer (15 l / ha) and Phylazonit Soil Inoculant (15 l / ha)

Cost: cc. 88 USD/ha ; cc. 75 EUR/ha

▶ **Results compared to control field :** + 900 kg/ha

📍 Martonvásár

Experiment: small parcel operational experiment Phylazonit Soil Regenerator (15 l / ha)

Cost: cc. 44 USD/ha ; cc. 37 EUR/ha

▶ **Results compared to control field:** + 700 kg/ha



Rape - 2019'

Zalaegerszeg

Experiment: operational experiment using Phylazonit Soil Regenerator (15 l / ha)

Cost: cc. 35 USD/ha ; cc. 30 EUR/ha

► **Results compared to control field:** + 400 kg/ha

Böhönye

Experiment: operational experiment using Phylazonit Stubble Decomposer (15 l / ha) and Phylazonit Soil Inoculant (15 l / ha)

Cost: cc. 69 USD/ha ; cc. 59 EUR/ha

► **Results compared to control field:** + 400 kg/ha

Ráckeve

Experiment: operational experiment using Phylazonit Stubble Decomposer and Energia Humin.

Cost: cc. 54 USD/ha ; cc. 75 EUR/ha

► **Results compared to control field:** + 210 kg/ha



Maize - 2019'

Rakamaz

Experiment: operational experiment using Phylazonit Soil Regenerator (15 l / ha).

Cost: cc. 44 USD/ha ; cc. 37 EUR/ha

▶ **Results compared to control field:** + 1700 kg/ha

Nemesgörzsöny

Experiment: large-scale experiment using Phylazonit Soil Inoculant (15 l / ha) and Energia Humin (5 l / ha)

Cost: cc. 54 USD/ha ; cc. 46 EUR/ha

▶ **Results compared to control field:** + 1600 kg/ha

Tiszabездéd

Experiment: operational experiment using Phylazonit Soil Regenerator (15 l / ha)

Cost: cc. 34 USD/ha ; cc. 29 EUR/ha

▶ **Results compared to control field:** + 730 kg/ha





Sunflower - 2019'

Tiszavasvári

Experiment: operational experiment using Phylazonit Soil Inoculant (15 l / ha)

Cost: cc. 34 USD/ha ; cc. 29 EUR/ha

► **Results compared to control field:** + 200 kg/ha

Nyíregyháza

Experiment: small parcel operation experiment using Phylazonit Soil Inoculant (15 l / ha).

Cost: cc. 34 USD/ha ; cc. 29 EUR/ha

► **Results compared to control field:** + 660 kg/ha

Hajdúböszörmény

Experiment: operational experiment using Phylazonit Soil Inoculant (10 l / ha)

Cost: cc. 23 USD/ha ; cc. 19 EUR/ha

► **Results compared to control field:** + 350 kg/ha

Soy - 2019'

📍 Nova

Experiment: field experiment using Phylazonit Soy Inoculant.

Control: first year treatment with Phylazonit Soy Inoculant (15 l / ha).

Treatment: 3 years of continuous Phylazonit treatment (15 l / ha).

Cost: cc. 34 USD/ha ; cc. 29 EUR/ha

▶ **Results compared to control field:**

- + 130 kg yield /ha
- + 1% protein content
- 1,5% moisture content
- + 8000 HUF (cc. 25 USD) income / ha



A series of tests by the Professional Organization of Hungarian Soil Bacteria Producers and Distributors

NÉBIH Baranya County Government Office - 2018

Experimental plant: soybean

Soil: KA: 38

PH: 5,34

Humus: 1.63 m / m% - medium humus content

Parcels: 2 untreated control parcels + standard control parcel + 6 treated parcels



The control parcels yielded between 2.9 t / ha and the parcels with different treatments yielded between 3.1-4 t / ha.

As for the soy, there is also a clear effect of soy inoculant treatments. Both the controls and the standard treatment (which received N fertilizers) were outperformed by these treatments. There was a formulation in the experiment that produced a 30% yield increase, nearly 1 ton of yield surplus compared to a better yielding control parcel.

The data of the previous 3 years perfectly supports the effectiveness of microbial inoculants and the need for soil inoculation.

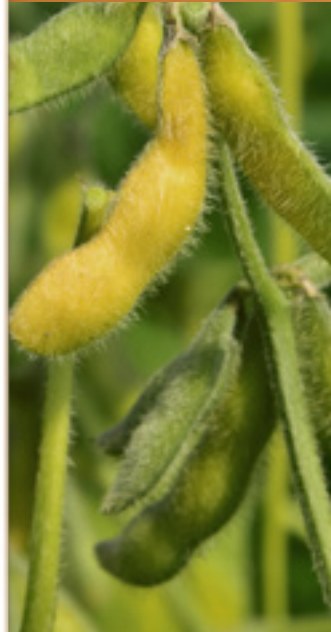
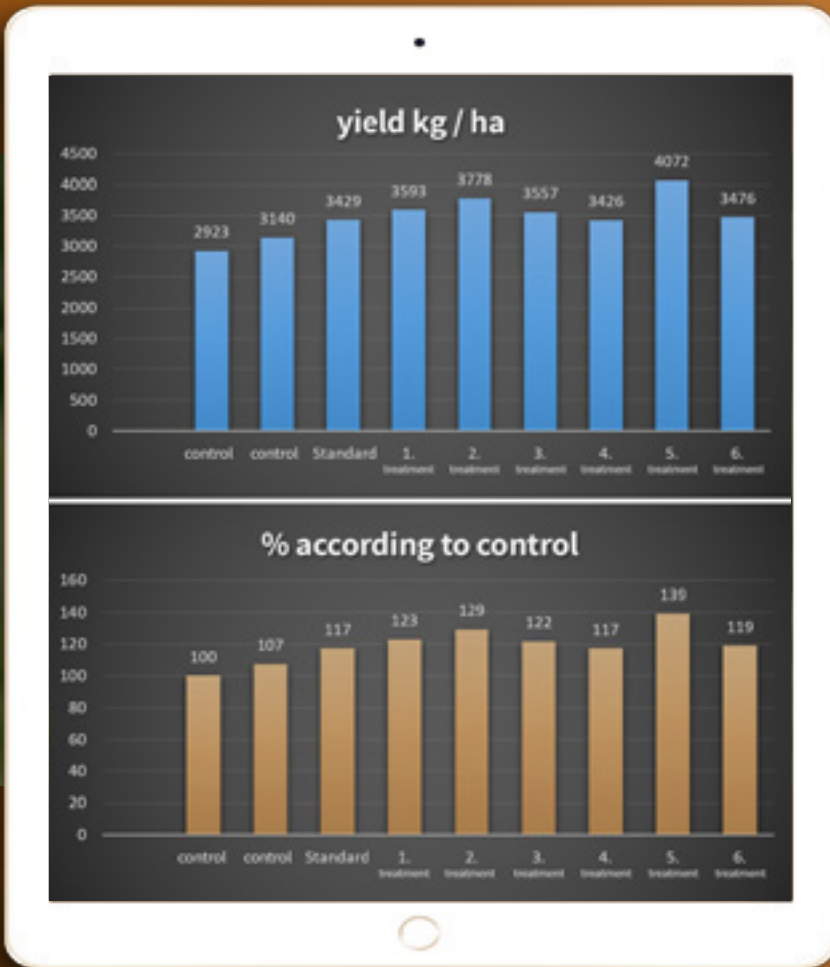



Foliar fertilizers - 2019'

📍 Dombrád

Experiment: operational experiment using Energia Humin (5 l / ha) and Energia Plus (30 l / ha).

Costs: cc. 50 USD/ha ; cc. 42 EUR/ha

▶ **Results compared to control field:** + 960 kg/ha

📍 Nyíregyháza - corn

Experiment: small parcel operational experiment Energia Humin (5 l / ha)

Costs: cc. 20 USD/ha ; cc. 17 EUR/ha

▶ **Results compared to control field:** + 850 kg/ha

📍 Derecske - CCM corn

Experiment: operational experiment using Energia Humin (5 l / ha)

Costs: cc. 20 USD/ha ; cc. 17 EUR/ha

▶ **Results compared to control field:** + 730 kg/ha

APPLICATION OF TECHNOLOGY

March

April

May

June



PHYLAZONIT[®] SOIL INOCULANT
PHYLAZONIT[®] SOIL REGENERATOR
before sowing or in one pass with sowing

EnergiaHumin
4-8 leaf age

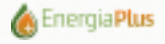

PHYLAZONIT[®] SOIL INOCULANT
PHYLAZONIT[®] SOIL REGENERATOR
before sowing or in one pass with sowing

EnergiaHumin
4-8 leaf age



EnergiaHumin → EnergiaPlus

from tillering to stalking

from stalk to flowering



EnergiaHumin until stalkink
EnergiaPlus from stalkink to flowering



PHYLAZONIT[®] SOY
before sowing or in one pass with sowing

EnergiaHumin
to 4 nodes

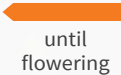

APPLICATION OF TECHNOLOGY

July

August

September

October

November

 **EnergiaPlus**
until tasselling

PHYLAZONIT **STUBBLE DECOMPOSER**
after harvest

 **EnergiaPlus**
until
growing bud

PHYLAZONIT **STUBBLE DECOMPOSER**
after harvest

PHYLAZONIT **STUBBLE DECOMPOSER**
after
harvest

PHYLAZONIT **SOIL INOCULANT**
PHYLAZONIT **SOIL REGENERATOR**
before sowing or in one run

 **EnergiaHumin**
from the age
of 3 leaves

PHYLAZONIT **STUBBLE D.**
after
harvest

SOIL INOCULANT
SOIL REGENERATOR
before sowing
or in one pass with sowing

 **EnergiaHumin**
from 4-leaf
stage

 **EnergiaPlus**
from the end of flowering
until the start of grain filling

PHYLAZONIT **STUBBLE DECOMPOSER**
after harvest

A photograph of two men standing in a field of tall grass or wheat. The man on the left is wearing a grey and white plaid shirt. The man on the right is wearing a red and black plaid shirt and a straw hat with a grey band. He is pointing his right arm towards the horizon. The background is a soft-focus field under a bright sky.

“The new application technology has made the use of Phylazonit convincing with which the bacterium is not damaged but gets into the soil immediately.”

Gergely Domján

“Innovation at highest level!”

Ferenc Gyenei

“With Phylazonit we are building our future.”

Imre Szűcs

“By using Phylazonit we have achieved spectacular soil structure improvements and higher yields with less nutrient replenishment.”

László Gajda

“Even in dry weather, Phylazonit does not dry out the soil. The water balance of the soil is visibly improving and it is so visible on the crops!”

Zoltán Szécsi

“Since we use Phylazonit regularly our fields are easier to cultivate. The economic benefits of the product can be felt more and more every year.”

Gábor Samu

Application options of Phylazonit products:

- Application in one pass with seeding by means of injection units mounted on the drill.
- Seedbed application with an application system mounted on a soil tillage machinery.
- Stubble treatment with an application system mounted on a soil tillage machinery.
- With an application system mounted on the front of the machinery.

Complete guidance regarding to bacterial formulations by the Phylazonit Advisory Team:

- Consultation on the background of the area, preferably based on soil testing.
- Discussion and proposals on nutrient management plans (for

example by stubble calculator).

- Selecting the products to be used (Phylazonit Soil Inoculant, Stubble Decomposer, Soil Regenerator, Phylazonit Soy).
- Incorporating the proposed bacterial products into the technology (determining the time and method of application, and selecting the most suitable machines for application from the machine pool).
- Delivery of the bacterial formulations within 48 hours to the specified site.
- Continuous monitoring and inspection.
- Customer satisfaction survey.
- Integration of the Energia foliar fertilizer family into technology with 3 purposes: stress relief, micro- and mesoelement replacement with Energia Humin, and support for intensive growth with the nitrogen content of Energia Plus.

WHY IS PHYLLER APPLICATOR USEFUL TO YOU?

- Our products can be applied in one pass with sowing or tillage.
- Minor trampling damage.
- Safe and more efficient application.
- Cost reduction.

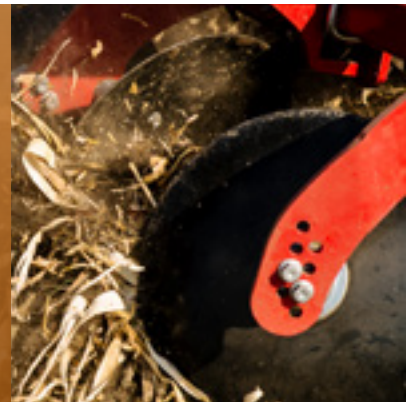



When applying microbiological products containing living organisms, our task is to apply **Phylazonit** with an agrotechnical operation that ensures optimal habitat for the bacteria; a living space where bacteria can perform all its useful task - so important to a farmer - in their life processes.

In view of the above, we have developed an application unit (**Tempo-sensor**) that can continuously change the application rate within the field by determining the speed and position of the machine. The aim of the sustainable management is to differentiate the input materials used in such a way that costs and related yields can be optimized. The bacterial products applied are not used at field level or based on a uniform principle but wi-

thin the field we increase the expected effect of the product by adjusting to the speed of the machines and the conditions of the soil.

Temposensor versions

The Tempo-sensor Basic adjusts the applied dose to the speed of the machines and stops the application at headland turning or when lifting the apparatus, ensuring the planned

amount of Phylazonit to be applied to that area. With this, it is actually possible that at a dose of 15 l / ha, 1500 liters of product will be sufficient for 100 hectares.

With the precision-based **Temposensor Precision** or **Professional** version, stubble residues can be selected based on biomass weight and yield map. Aerial or satellite images or yield map may be used to infer the amount of stem residue to be decomposed. Depending on this, the applied amount of compound can be increased or decreased.

In the treatment of the root zone, the treatment zones can be designated in the possession of soil test results. Elevated bacterial counts can be used in

high nutrient uptake zones and reduced bacterial counts in lower nutrient uptake zones.

TEMPOSENSOR PROVIDES THE FOLLOWING BENEFITS:

- Accurate application of Phylazonit products to all parts of the area.
- Rate-based application.
- Automatically pauses application at headland turns and stops.
- Immediately indicates possible blockages, leaks, nozzle failure.
- Can be mounted on any machine, regardless of the size of the farm
- Cost-efficient.

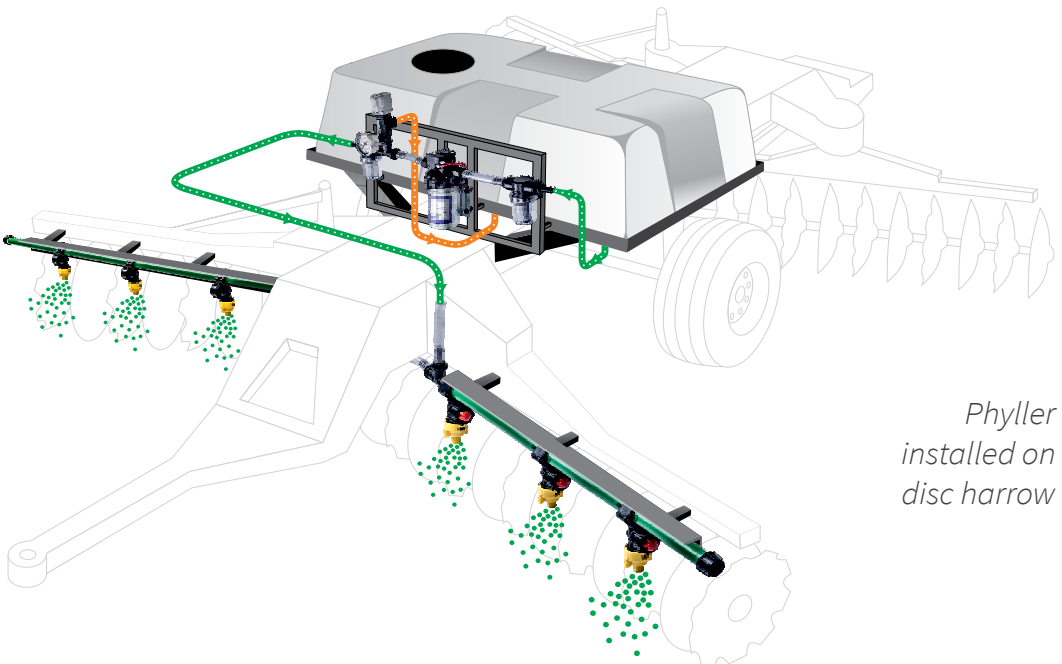

*Phyller
installed on
disc harrow*



www.phylazonit.com

